

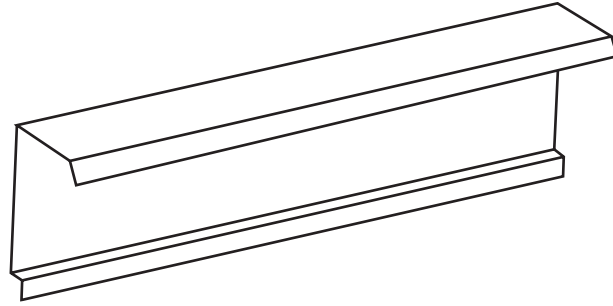

ACCESSOIRES DE BARDAGE

Tous travaux de pliage à la demande

⑩ Bande de rive

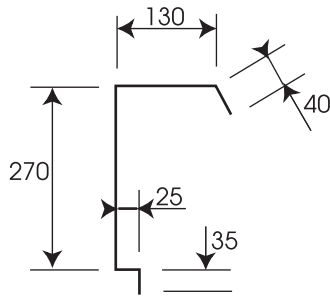

- largeur développée : 500 mm.

Raccord d'angle

⑪

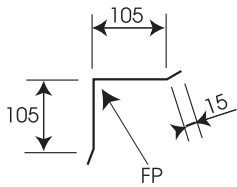

⑪ Bis

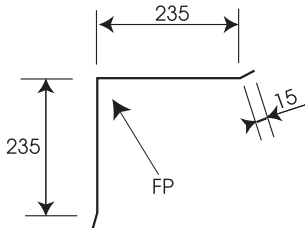

⑫

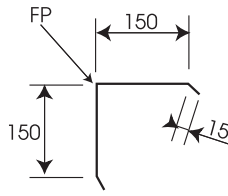

⑫ Bis

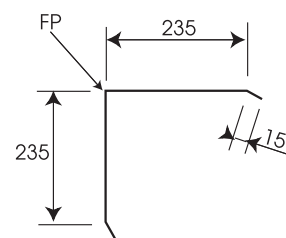

INTÉRIEUR

EXTÉRIEUR

⑬ Coiffe d'acrotère couvertine

- cote x à la demande.
- éclisse sur demande.

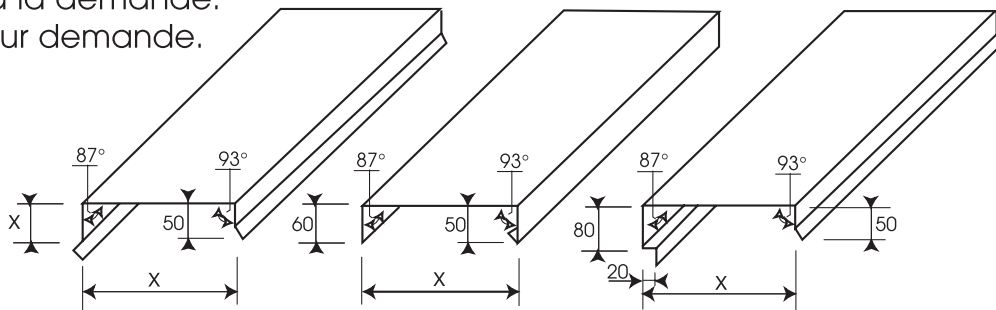

⑭ Larmier ou bavette

- largeur développée.

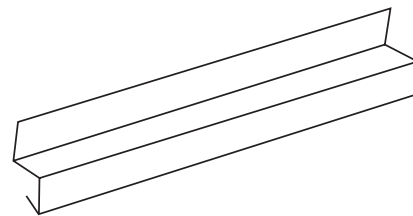
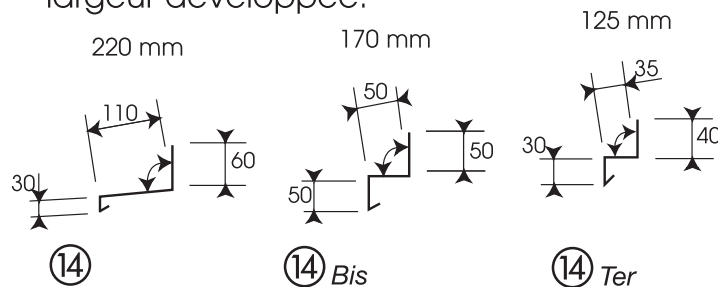

- $\hat{\alpha}$ standard 95°
- éclisse sur demande.